

DIMENSIONS FOR OVERALL HEIGHT AND LENGTH ARE APPROXIMATE

OVERALL HEIGHT = 109.75"

OVERALL WIDTH WITH RUB

RAILS & FENDERETTES = 98"

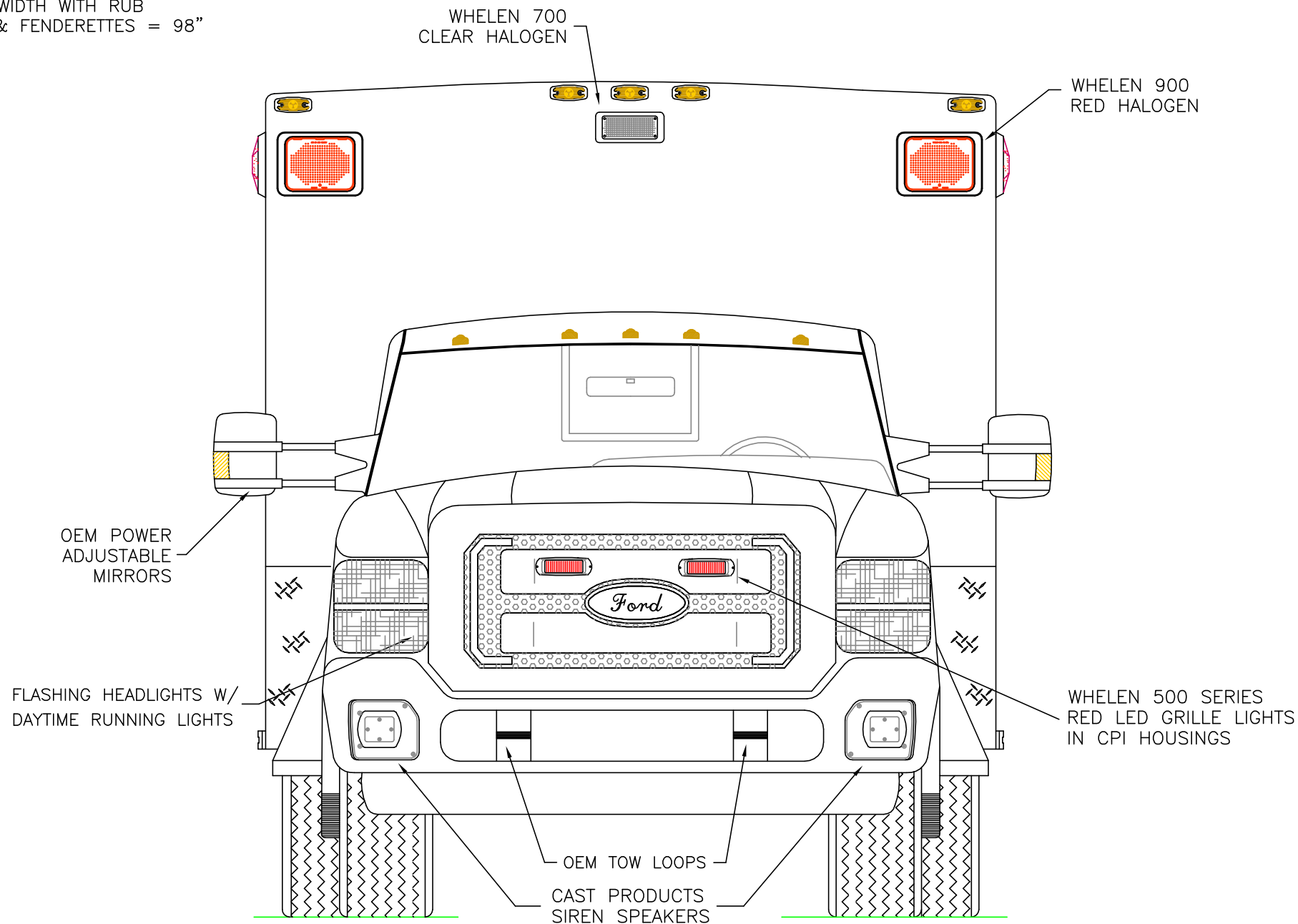

THIS DRAWING IS FOR REPRESENTATIONAL PURPOSES ONLY. DETAILS ARE CONCEPTUAL AND ARE SUBJECT TO CHANGE DURING DESIGN AND CONSTRUCTION
DIMENSIONS ARE APPROXIMATE UNLESS NOTED OTHERWISE TO MEET A SPECIFIC CUSTOMER NEED.



2012 FRONT EXTERIOR VIEW
BRAUN LIBERTY TYPE-I / FORD F-450 CHASSIS

1:17

DATE:	06 JULY 11
DWG.	GLF
REV.	NR

DRAWING NO.	LIBERTY-F-1
-------------	-------------

DIMENSIONS FOR OVERALL HEIGHT AND LENGTH ARE APPROXIMATE
 OVERALL HEIGHT = 109.75"
 OVERALL WIDTH WITH RUB
 RAILS & FENDERETTES = 98"

(1) WHELEN 900 AMBER HALOGEN

(2) WHELEN 900 CLEAR HALOGEN LOAD LIGHTS

(2) WHELEN 900 RED HALOGEN

CAST PRODUCTS
 DOOR GRABBERS

LED LICENSE
 PLATE LIGHT

MUD FLAPS

COT PROTECTOR
 ON STEP EDGE

ONE (1) EACH SIDE
 WHELEN
 600 INCANDESCENT BRAKE/TAIL,
 600 INCANDESCENT TURN
 600 HALOGEN BACK-UP

INDEPENDENT BUMPER WITH
 FLIP-UP CENTER STEP AND
 TOW HOOKS

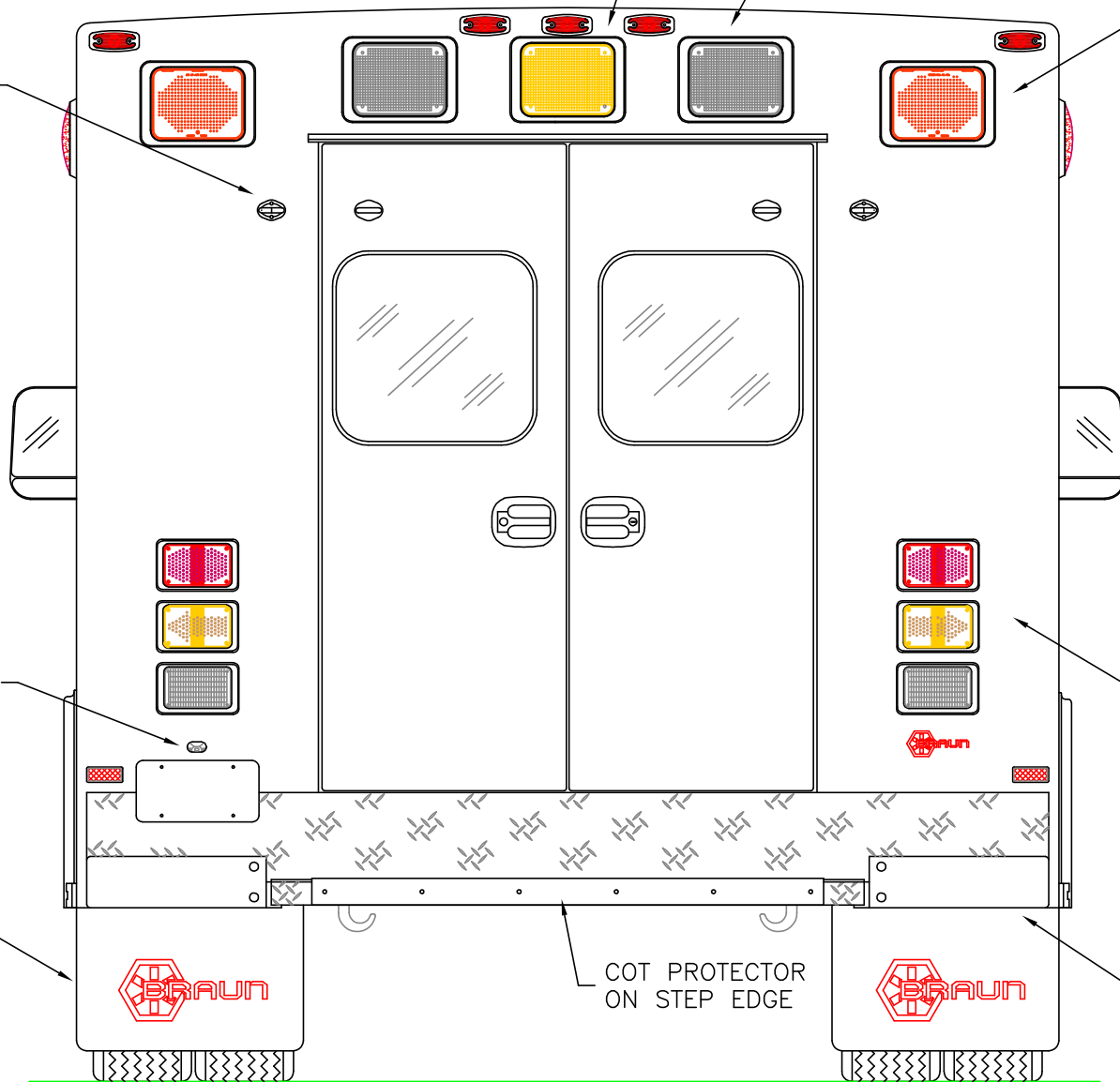

THIS DRAWING IS FOR REPRESENTATIONAL PURPOSES ONLY. DETAILS ARE CONCEPTUAL AND ARE SUBJECT TO CHANGE DURING DESIGN AND CONSTRUCTION
 DIMENSIONS ARE APPROXIMATE UNLESS NOTED OTHERWISE TO MEET A SPECIFIC CUSTOMER NEED.



2012 REAR EXTERIOR VIEW
 BRAUN LIBERTY TYPE-I

DATE:		06 JULY 11	
DWG.	REV.	GLF	NR

DRAWING NO.	LIBERTY-F-2
-------------	-------------

DIMENSIONS FOR OVERALL HEIGHT AND LENGTH ARE APPROXIMATE
 OVERALL HEIGHT = 109.75"
 OVERALL LENGTH = 288.5"
 MODULE LENGTH = 156"

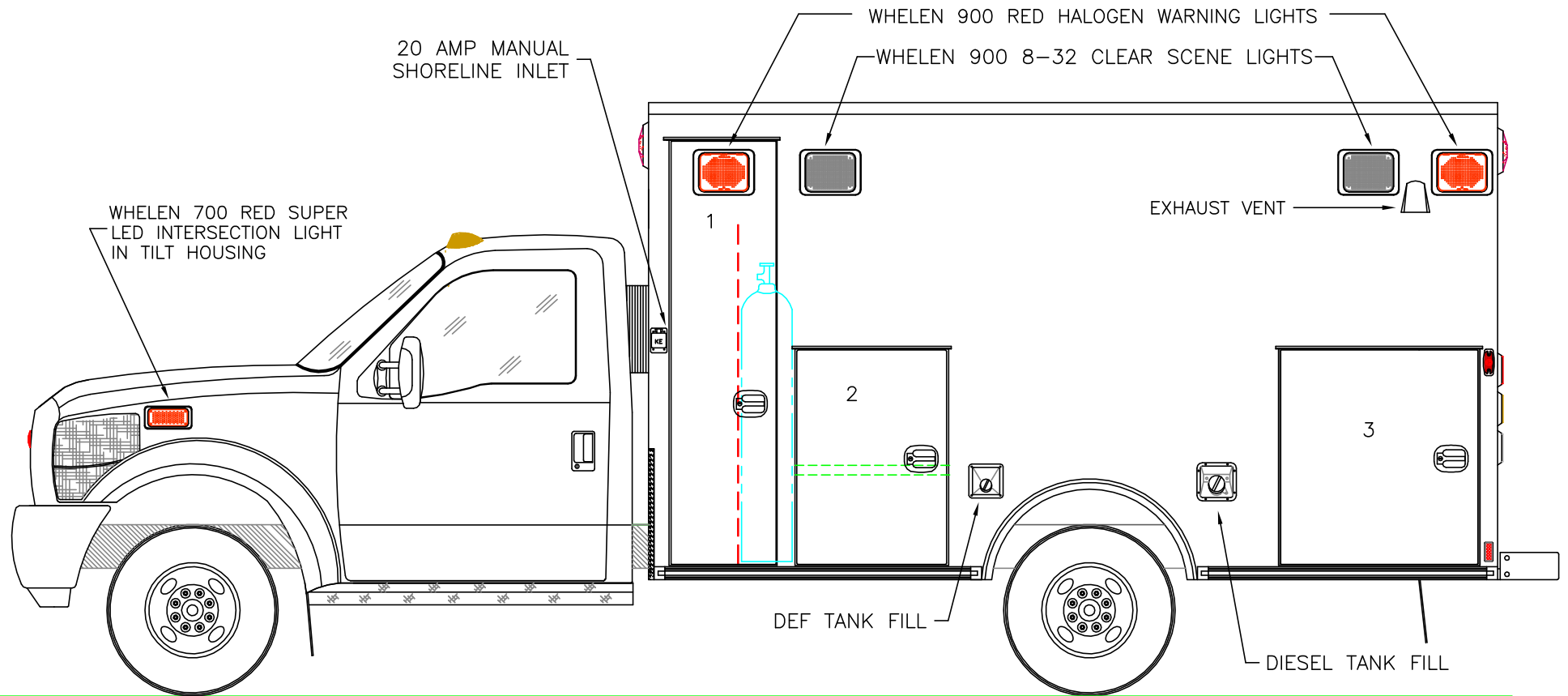

COMPARTMENT

O.S.S #1
 CLEAR OPENING: 76.75h x 16.00w
 INSIDE DIM'S.: 77.75h x 20.75w x 20.75d
 OXYGEN/BACKBOARD STORAGE

O.S.S #2
 CLEAR OPENING: 38.50h x 24.50w
 INSIDE DIM'S.: 41.50h x 28.25w x 20.75d
 ONE (1) ADJUSTABLE SHELF

O.S.S #3
 CLEAR OPENING: 38.50h x 33.25w
 INSIDE DIM'S.: 41.50h x 37.25w x 20.75d

THIS DRAWING IS FOR REPRESENTATIONAL PURPOSES ONLY. DETAILS ARE CONCEPTUAL AND ARE SUBJECT TO CHANGE DURING DESIGN AND CONSTRUCTION
 DIMENSIONS ARE APPROXIMATE UNLESS NOTED OTHERWISE TO MEET A SPECIFIC CUSTOMER NEED.



2012 STREETSIDE EXTERIOR VIEW
 BRAUN LIBERTY TYPE-I / FORD F-450 CHASSIS

1:28

DATE:	06 JULY 11
DWG.	REV.
GLF	NR

DRAWING NO.
 LIBERTY-F-3

DIMENSIONS FOR OVERALL HEIGHT AND LENGTH ARE APPROXIMATE

OVERALL HEIGHT = 109.75"

OVERALL LENGTH = 288.5"

MODULE LENGTH = 156"

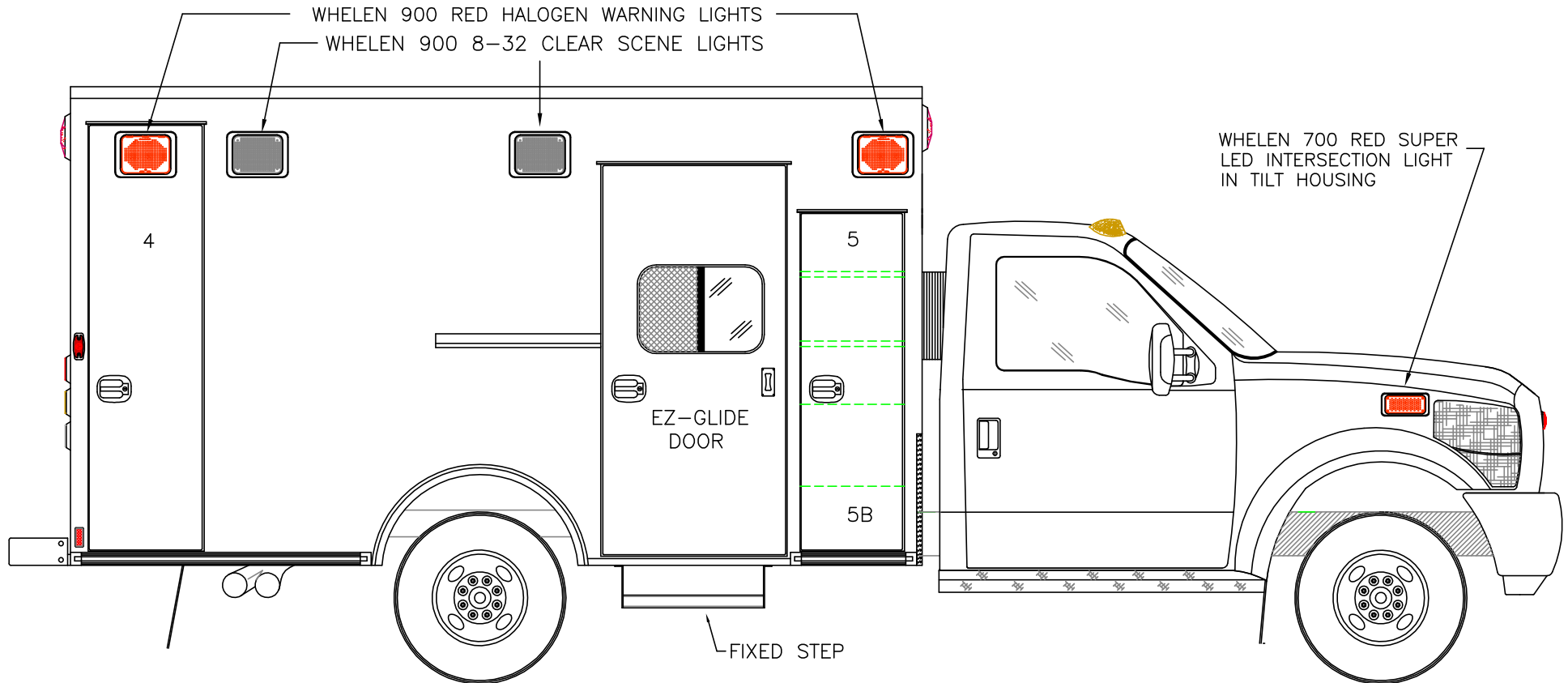

COMPARTMENT

O.S.S #4

CLEAR OPENING: 76.75h x 18.25w

INSIDE DIM'S.: 77.75h x 21.50w x 20.50d

BACKBOARD/SCOOP STORAGE

O.S.S #5

CLEAR OPENING: 60.25h x 14.00w

INSIDE DIM'S. 5A: SEE PARTITION INTERIOR VIEW

INSIDE/OUTSIDE STORAGE WITH TWO (2) ADJUSTABLE SHELVES

INSIDE DIM'S. 5B: 13.50h x 19.00w x 17.50d

THIS DRAWING IS FOR REPRESENTATIONAL PURPOSES ONLY. DETAILS ARE CONCEPTUAL AND ARE SUBJECT TO CHANGE DURING DESIGN AND CONSTRUCTION
DIMENSIONS ARE APPROXIMATE UNLESS NOTED OTHERWISE TO MEET A SPECIFIC CUSTOMER NEED.



2012 CURBSIDE EXTERIOR VIEW
BRAUN LIBERTY TYPE-I / FORD F-450 CHASSIS

1:28

DATE:	06 JULY 11	DRAWING NO.	LIBERTY-F-4
DWG.	GLF	REV.	

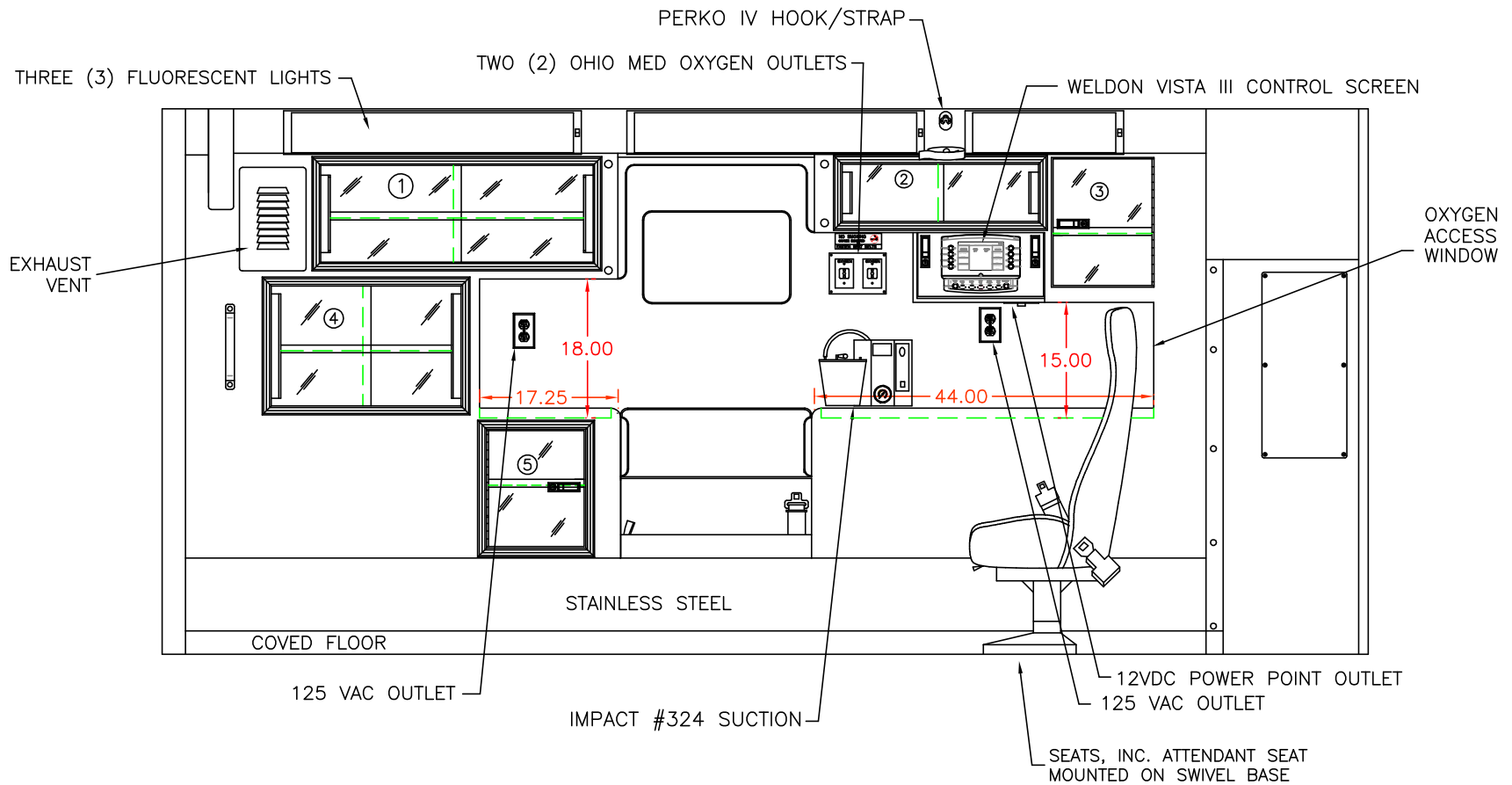

COMPARTMENT

- #1 DOOR OPENING: 12.50h x 35.25w
INSIDE DIMS: 14.50h x 37.00w x 17.25d
ONE (1) ADJUSTABLE SHELF
- #2 DOOR OPENING: 7.50h x 25.50w
INSIDE DIMS: 9.75h x 27.00w x 17.25d
- #3 DOOR OPENING: 16.75h x 13.25w
INSIDE DIMS: 19.00h x 13.25w x 17.25d
ONE (1) ADJUSTABLE SHELF
HINGED ACRYLIC DOOR
ONE (1) LOCKING LEVER LATCH

- #4 DOOR OPENING: 15.00h x 25.25w
INSIDE DIMS: 18.50h x 29.00w x 17.25d
ONE (1) ADJUSTABLE SHELF
- #5 DOOR OPENING: 17.00h x 13.25w
INSIDE DIMS: 18.00h x 18.00w x 17.25d
ONE (1) ADJUSTABLE SHELF
LEFT-HINGED ACRYLIC DOOR
ONE (1) LOCKING LEVER LATCH

ALUMINUM CABINETS

THIS DRAWING IS FOR REPRESENTATIONAL PURPOSES ONLY. DETAILS ARE CONCEPTUAL AND ARE SUBJECT TO CHANGE DURING DESIGN AND CONSTRUCTION DIMENSIONS ARE APPROXIMATE UNLESS NOTED OTHERWISE TO MEET A SPECIFIC CUSTOMER NEED.



2012 STREETSIDE INTERIOR VIEW
BRAUN LIBERTY TYPE-I

DATE: 06 JULY 11	
DWG. GLF	REV. NR

DRAWING NO.
LIBERTY-F-5

1:20

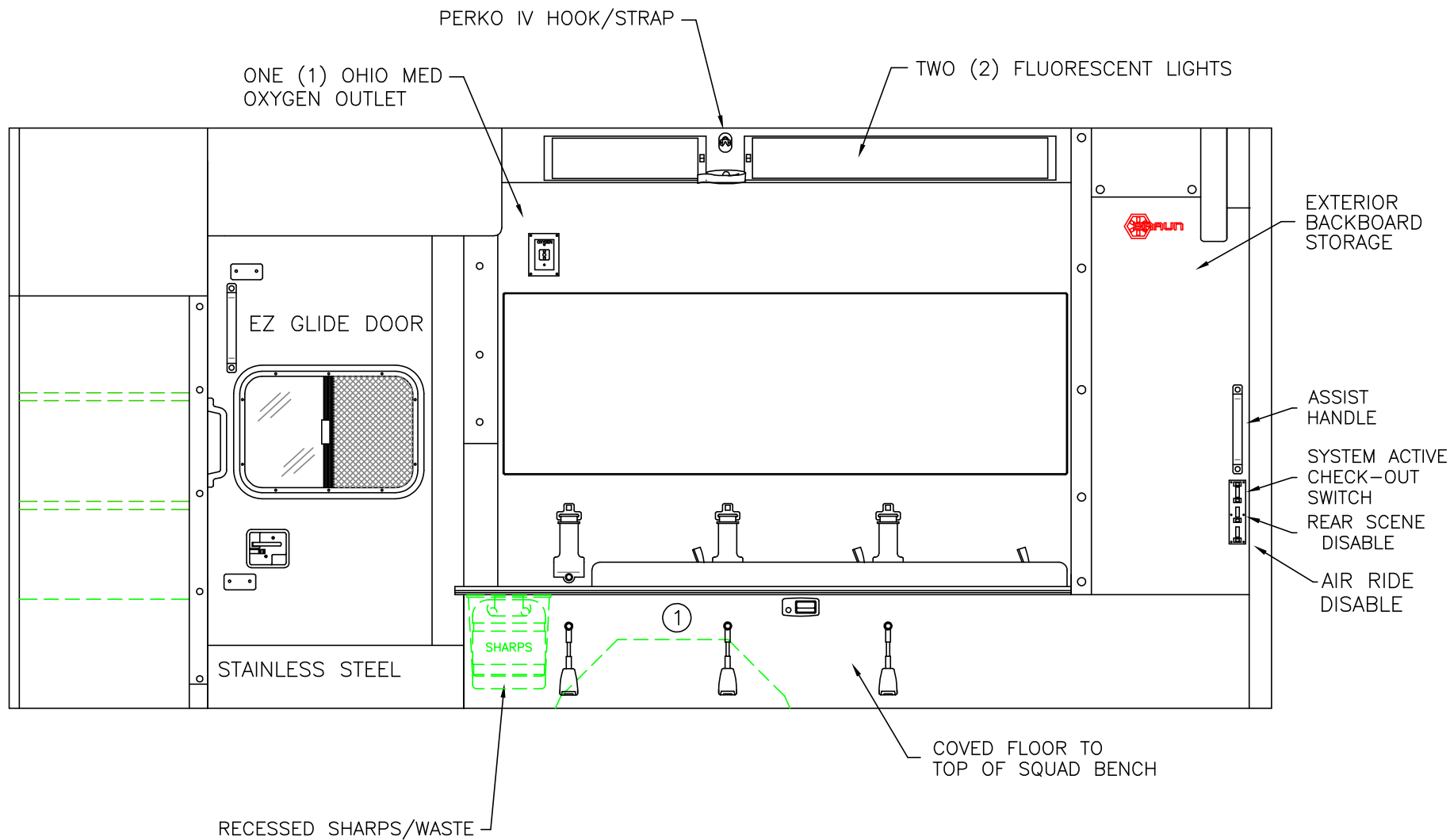

#1 INSIDE DIM'S.: 14.50h x 74.75w x 20.00d

ALUMINUM CABINETS

THIS DRAWING IS FOR REPRESENTATIONAL PURPOSES ONLY. DETAILS ARE CONCEPTUAL AND ARE SUBJECT TO CHANGE DURING DESIGN AND CONSTRUCTION DIMENSIONS ARE APPROXIMATE UNLESS NOTED OTHERWISE TO MEET A SPECIFIC CUSTOMER NEED.



2012 CURBSIDE INTERIOR VIEW
BRAUN LIBERTY TYPE-I

DATE:	06 JULY 11	DRAWING NO.	LIBERTY-F-6
DWG.	GLF	REV.	NR
1:18			

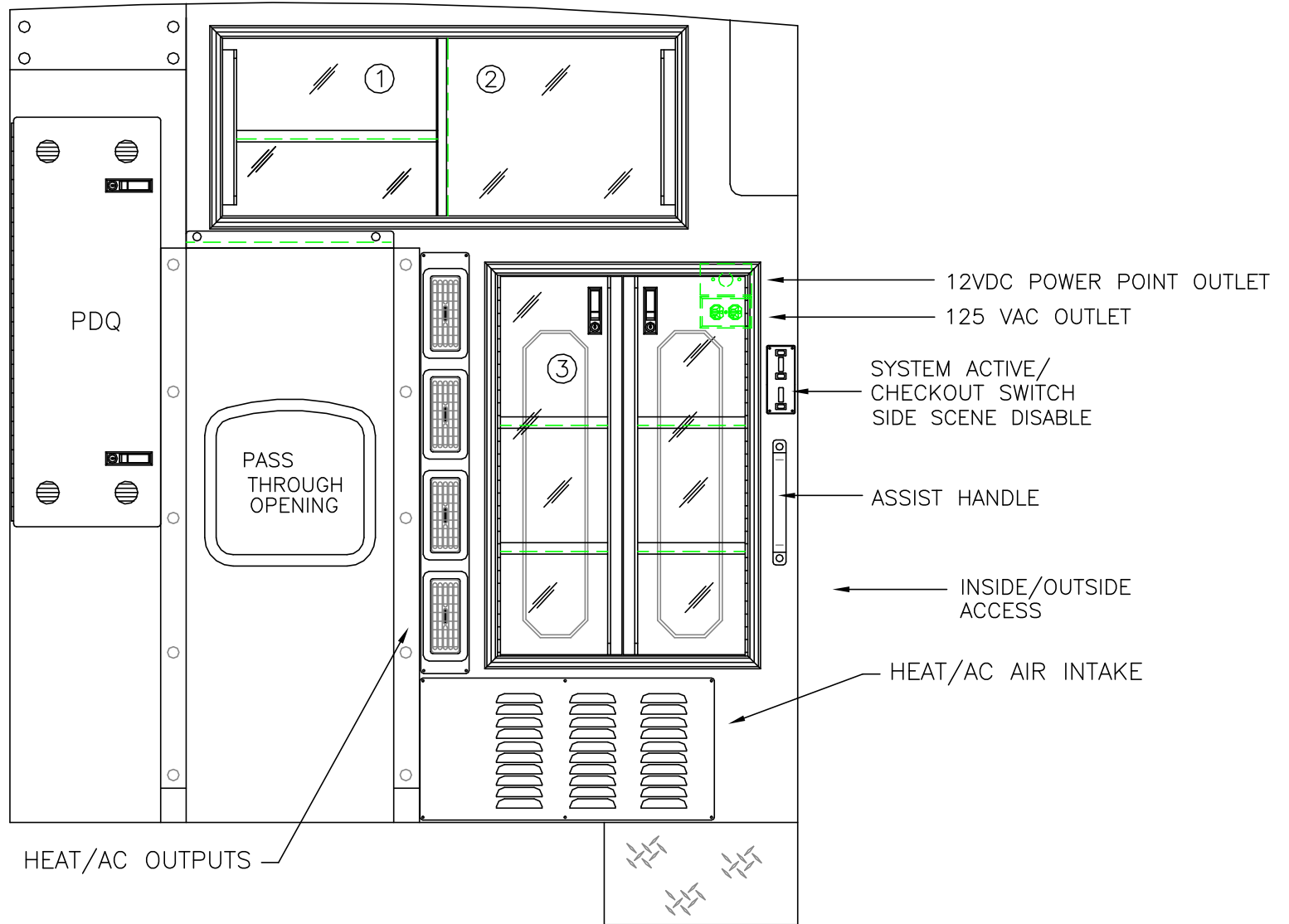

COMPARTMENT

#1-#2 DOOR OPENING: 15.50h x 39.75w
 INSIDE DIMS: 17.75h x 44.00w x 20.00d
 PERMANENT DIVIDER(CENTERED)
 ONE (1) ADJUSTABLE SHELF IN COMPARTMENT #1

#3 DOOR OPENING: 33.50h x 22.00w
 INSIDE DIMS: 36.75h x 25.75w x 22.00d
 RECESSED .375" ACRYLIC DOORS WITH FULL LENGTH HANDLES
 TWO (2) LOCKING LEVER LATCHES
 TWO (2) ADJUSTABLE SHELVES

ALUMINUM CABINETS

THIS DRAWING IS FOR REPRESENTATIONAL PURPOSES ONLY. DETAILS ARE CONCEPTUAL AND ARE SUBJECT TO CHANGE DURING DESIGN AND CONSTRUCTION
 DIMENSIONS ARE APPROXIMATE UNLESS NOTED OTHERWISE TO MEET A SPECIFIC CUSTOMER NEED.

2012 PARTITION INTERIOR VIEW
 BRAUN LIBERTY TYPE-I



DATE: 06 JULY 11	
DWG. GLF	REV. NR

DRAWING NO. LIBERTY-F-7

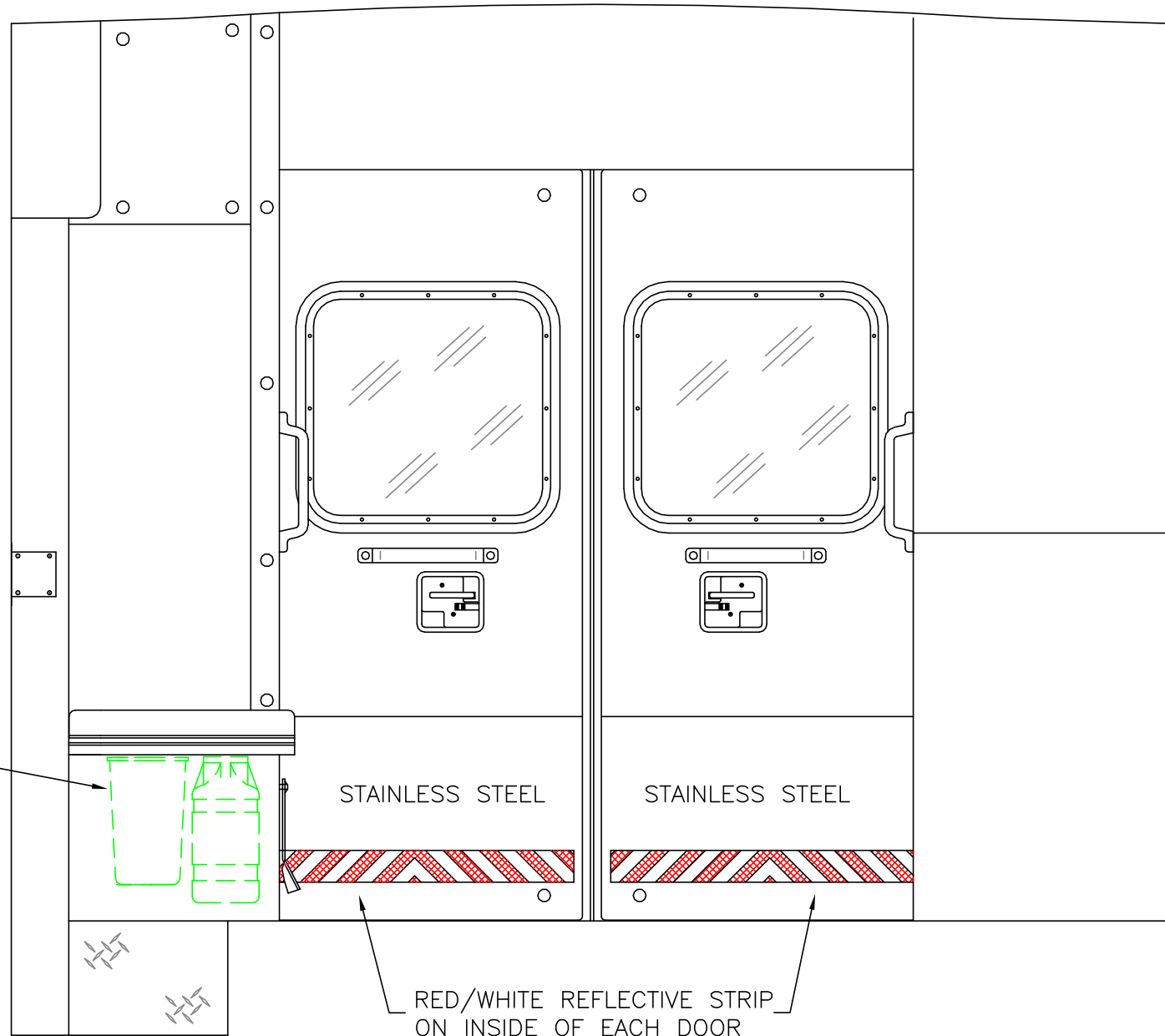

RECESSED SHARPS/
TRASH

STAINLESS STEEL

STAINLESS STEEL

RED/WHITE REFLECTIVE STRIP
ON INSIDE OF EACH DOOR

THIS DRAWING IS FOR REPRESENTATIONAL PURPOSES ONLY. DETAILS ARE CONCEPTUAL AND ARE SUBJECT TO CHANGE DURING DESIGN AND CONSTRUCTION
DIMENSIONS ARE APPROXIMATE UNLESS NOTED OTHERWISE TO MEET A SPECIFIC CUSTOMER NEED.



2012 REAR INTERIOR VIEW
BRAUN LIBERTY TYPE-I

1:12

DATE:	06 JULY 11
DWG.	REV.
GLF	NR

DRAWING NO.
LIBERTY-F-8

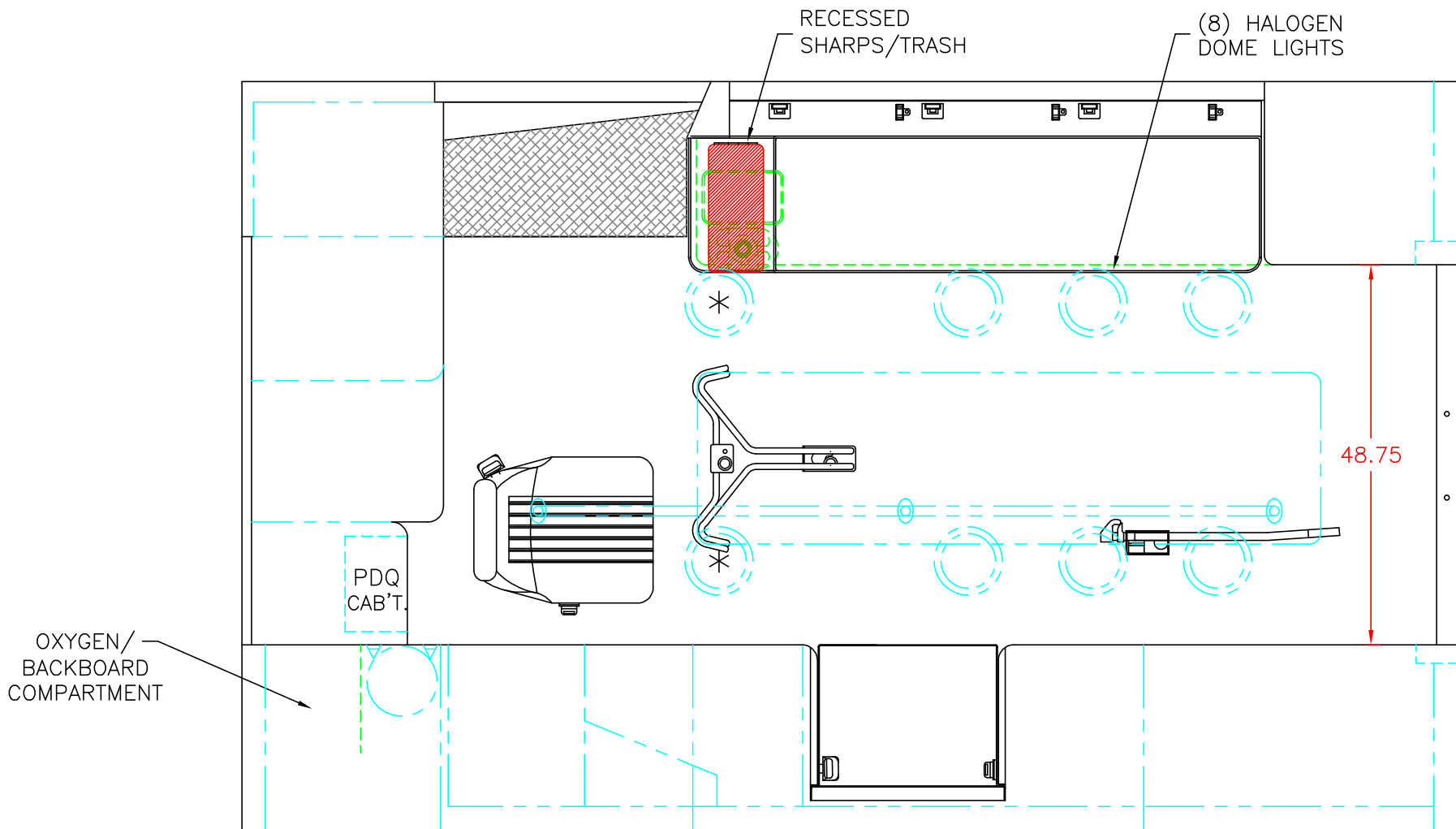

* TWO (2) ANTENNA BASES LOCATED OUTBOARD OF DOME LIGHTS WITH COAX SERVICE LOOP

STRYKER CENTER MOUNT COT HARDWARE

MODULE WIDTH = 96"
 MODULE LENGTH = 156"
 MODULE HEAD ROOM = 72"

THIS DRAWING IS FOR REPRESENTATIONAL PURPOSES ONLY. DETAILS ARE CONCEPTUAL AND ARE SUBJECT TO CHANGE DURING DESIGN AND CONSTRUCTION DIMENSIONS ARE APPROXIMATE UNLESS NOTED OTHERWISE TO MEET A SPECIFIC CUSTOMER NEED.



2012 FLOOR INTERIOR VIEW
 BRAUN LIBERTY TYPE-I

DATE:	06 JULY 11	DRAWING NO.	LIBERTY-F-9
DWG.	GLF	REV.	NR
1:20			